

English

OPERATING MANUAL

Refrigerated and Heating Circulators

F12-EH F25-EH

F32-EH F33-EH F34-EH

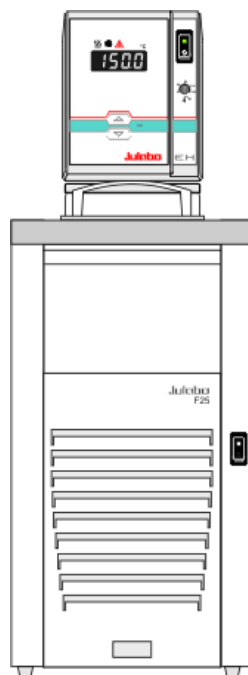

Julabo

JULABO WEST
2575 Pioneer Avenue, Suite 102
Vista, CA 92081

☎ (760) 842-8010
📄 (760) 842-8015
✉ info @ julabo.com
🌐 www.julabo.com

Julabo

JULABO EAST
754 Roble Road, Suite 180
Allentown, PA 18109

☎ (610) 231-0250
📄 (610) 231-0260
✉ info @ julabo.com
🌐 www.julabo.com

1.953.0261 07/10

Congratulations!

You have made an excellent choice.

JULABO thanks you for the trust you have placed in us.

This operating manual has been designed to help you gain an understanding of the operation and possible applications of our circulators. For optimal utilization of all functions, we recommend that you thoroughly study this manual prior to beginning operation.

Quality Management System



The JULABO Quality Management System:

Temperature control devices for research and industry are developed, produced, and distributed according to the requirements of DIN EN ISO 9001:2000.

Certificate Registration No. 01 100044846

Unpacking and inspecting

Unpack the circulator and accessories and inspect them for possible transport damage. Damage should be reported to the responsible carrier, railway, or postal authority, and a damage report should be requested. These instructions must be followed fully for us to guarantee our full support of your claim for protecting against loss from concealed damage. The form required for filing such a claim will be provided by the carrier.

Printed in Germany

Changes without prior notification reserved

TABLE OF CONTENTS

Operating manual	4
1. Intended use	4
1.1. Description	4
2. Operator responsibility – Safety recommendations	4
2.1. Disposal.....	6
2.2. Technical specifications.....	7
Operating instructions	11
3. Safety notes for the user.....	11
3.1. Explanation of safety notes	11
3.2. Explanation of other notes.....	11
3.3. Safety recommendations.....	11
4. Operating controls and functional elements.....	14
5. Preparations	16
5.1. Installation	16
5.2. Bath fluids.....	17
5.3. Filling / Draining.....	18
5.4. Temperature application to external systems	19
5.4.1. Tubing.....	19
5.5. Adjusting the pump flow	20
6. Operating procedures	21
6.1. Power connection	21
6.2. Switching on / Start - Stop	21
6.3. Automatic / non-automatic start mode	22
6.4. Setting the temperatures	23
6.5. ATC - Absolute Temperature Calibration.....	24
6.6. Timer function.....	25
6.6.1. Setting the time	25
6.6.2. Timer operation.....	25
6.7. Safety installations according to IEC 61010-2-010	26
6.7.1. Excess temperature protection	26
6.7.2. Low liquid level protection.....	26
7. Troubleshooting guide / Error messages	27
8. Electrical connections	29
9. Cleaning / repairing the unit.....	29
10. WARRANTY PROVISIONS	31

Operating manual

1. Intended use

JULABO circulators have been designed to control the temperature of specific fluids in a bath tank. The units feature pump connections for temperature control of external systems (loop circuit).



JULABO circulators are not suitable for direct temperature control of foods, semi-luxury foods and tobacco, or pharmaceutical and medical products. Direct temperature control means unprotected contact of the object with the bath medium (bath fluid).

1.1. Description

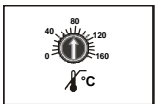
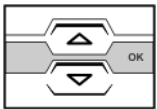

- The circulators are operated via the splash-proof keypad. The implemented microprocessor technology allows to set and to store the setpoint that can be indicated on the LED temperature display.
- The PID temperature control adapts the heat supplied to the thermal requirements of the bath.
- ATC - Absolute Temperature Calibration (1-point calibration)
- Safety installations conforming to IEC 61010-2-010
The excess temperature protection is a safety installation independent from the control circuit.
The safety value is set using a tool (screwdriver).
If the low level protection device is triggered, a complete shutdown of the heater and circulating pump is effected.
- Electrical connection:
Alarm output for external alarm message or control of JULABO refrigerating baths.

2. Operator responsibility – Safety recommendations

The products of JULABO ensure safe operation when installed, operated, and maintained according to common safety regulations. This section explains the potential dangers that may arise when operating the circulator and also specifies the most important safety precautions to preclude these dangers as far as possible.

- The operator is responsible for the qualification of the personnel operating the units.
- The personnel operating the units should be regularly instructed about the dangers involved with their job activities as well as measures to avert these dangers.
- Make sure all persons tasked with operating, installing, and maintaining the unit have read and understand the safety information and operating instructions.
- When using hazardous materials or materials that could become hazardous, the circulator may be operated only by persons who are absolutely familiar with these materials and the circulator. These persons must be fully aware of possible risks.

If you have any questions concerning the operation of your unit or the information in this manual, please contact us!

Contact	JULABO WEST	JULABO EAST
	2575 Pioneer Avenue, Suite 102 Vista, CA 92081 ☎ (760) 842-8010 📠 (760) 842-8015 ✉ info @ julabo.com 🌐 www.julabo.com	754 Roble Road, Suite 180 Allentown, PA 18109 ☎ (610) 231-0250 📠 (610) 231-0260 ✉ info @ julabo.com 🌐 www.julabo.com

Safety instructions for the operator:

- You have received a product designed for industrial use. Nevertheless, avoid strikes to the housing, vibrations, damage to the operating-element panel (keypad, display), and contamination.
- Make sure the product is checked for proper condition regularly (depending on the conditions of use). Regularly check (at least every 2 years) the proper condition of the mandatory, warning, prohibition and safety labels.
- Make sure that the mains power supply has low impedance to avoid any negative effects on instruments being operated on the same mains.
- This unit is designed for operation in a controlled electromagnetic environment. This means that transmitting devices (e.g., cellular phones) should not be used in the immediate vicinity. Magnetic radiation may affect other devices with components sensitive to magnetic fields (e.g., monitors). We recommend maintaining a minimum distance of 1 m.
- Permissible ambient temperature: max. 40 °C, min. 5 °C.
- Permissible relative humidity: 50% (40 °C).
- Do not store the unit in an aggressive atmosphere.
- Protect the unit from contamination.
- Do not expose the unit to sunlight.

Appropriate operation

Only qualified personnel is authorized to perform configuration, installation, maintenance and repairs of the circulator.

Routine operation can also be carried out by untrained personnel who should however be instructed by trained personnel.

Use:

The bath can be filled with flammable materials. Fire hazard!

There might be chemical dangers depending on the bath medium used.

Observe all warnings for the used materials (bath fluids) and the respective instructions (safety data sheets).

Insufficient ventilation may result in the formation of explosive mixtures. Only use the unit in well ventilated areas. The unit is not for use in explosive atmosphere.



Only use recommended materials (bath fluids). Only use non-acid and non corroding materials.

Operator responsibility – Safety recommendations

When using hazardous materials or materials that could become hazardous, **the operator must** affix the enclosed safety labels to the front of the unit so they are highly visible:

If this unit is intended for use within the United States of America, all 3 warning labels **must** be affixed to the housing of the unit prior to use.

Directions for the positioning of the individual warning labels are enclosed with the warning labels included in the delivery. Warning labels must be easily visible to users.

1		Warning label W00: Colors: yellow, black Danger area. Attention! Observe instructions. (operating manual, safety data sheet)
2 or 2	 	Mandatory label M018: Colors: blue, white Carefully read the user information prior to beginning operation. Scope: EU Semi S1-0701 Table A1-2 #9 Carefully read the user information prior to beginning operation. Scope: USA, NAFTA
3	<div style="border: 1px solid black; padding: 5px;"> <p>WARNING: This product contains chemicals known to the state of California to cause cancer, birth defects or other reproductive harm.</p> </div>	Warning label Proposition 65

Particular care and attention is necessary because of the wide operating range.

There are thermal dangers:

Burn, scald, hot steam, hot parts and surfaces that can be touched.

	Warning label W26: Colors: yellow, black Hot surface warning. (The label is put on by JULABO)
---	---

Observe the instructions in the manuals for instruments of a different make that you connect to the circulator, particularly the respective safety recommendations. Also observe the pin assignment of plugs and technical specifications of the products.

2.1. Disposal

The product may be used with oil as bath fluid. These oils fully or partially consist of mineral oil or synthetic oil. For disposal, observe the instructions in the safety data sheets.

This unit contains the refrigerants R134a – at this time considered not to have any negative effects on the ozone layer. However, during the long operating period of the unit, disposal prescriptions may change. So only qualified personnel should take care of disposal.

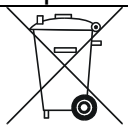
	Contact an authorized waste management company in your country. Disposal with household waste (unsorted waste) or similar collections of municipal waste is not permitted!
---	---

2.2. Technical specifications

		F12-EH	F25-EH
Working temperature range	°C	-20 ... 150	-28 ... 150
Temperature stability	°C	±0.03	±0.03
Temperature selection		digital	digital
Temperature indication		LED	LED
Resolution	°C	0.1	0.1
ATC - Absolute Temperature Calibration		1-point	1-point
Temperature control		PID1	PID1
Heater wattage (at 230 V)	kW	2.0	2.0
Heater wattage (at 115 V)	kW	1.0	1.0
Cooling capacity	°C	+20 0 -20	+20 0 -20
Medium ethanol	kW	0.16 0.1 0.02	0.26 0.2 0.06
Refrigerant		R134a	R134a
Circulating pump:			
discharge, max.at 0 bar	l/min	15	15
pressure, max. at 0 l	bar	0,35	0,35
Electrical connections:			
External alarm device	Vdc/mA	24-0 / max. 25	24-0 / max. 25
Overall dimensions (WxDxH)	cm	20x36x56	23x42x61
Bath opening (WxL)	cm	13x15	12x14
Bath depth	cm	13	14
Filling volume from ... to	liters	3 ... 4.5	3 ... 4.5
Weight	kg	22	30
Ambient temperature	°C	5 ... 40	5 ... 40
Mains power connection 230 V/50 Hz			
	V/ Hz	207-253 / 50	207-253 / 50
Current input (at 230 V)	A	11	12
Current input (at 230 V) CH	A	<9 + 1>	<9 + 2>
Mains power connection 230 V/60 Hz			
	V/ Hz	207-253 / 60	207-253 / 60
Current input (at 230 V)	A	11	12
Mains power connection 115 V/60 Hz			
	V/ Hz	103-127 / 60	103-127 / 60
Current input (at 115 V)	A	12	13
Mains power connection 100 V/50-60 Hz			
	V/ Hz	90-110V/50-60Hz	90-110V/50-60Hz
Current input (at 100 V)	A	15	13

All measurements have been carried out at: rated voltage and frequency
 ambient temperature: 20 °C Technical changes without prior notification reserved.

		F32-EH	
Working temperature range	°C	-35 ... 150	
Temperature stability	°C	±0.03	
Temperature selection		digital	
Temperature indication		LED	
Resolution	°C	0.1	
ATC - Absolute Temperature Calibration		1-point	
Temperature control		PID1	
Heater wattage (at 230 V)	kW	2.0	
Heater wattage (at 115 V)	kW	1.0	
Cooling capacity	°C	+20 0 -20	
Medium ethanol	kW	0.45 0.39 0.15	
Refrigerant		R134a	
Circulating pump:			
discharge, max.at 0 bar	l/min	15	
pressure, max. at 0 l	bar	0.35	
Electrical connections:			
External alarm device	Vdc/mA	24-0 / max. 25	
Overall dimensions (WxDxH)	cm	31x42x64	
Bath opening (WxL)	cm	18x12	
Bath depth	cm	15	
Filling volume from ... to	liters	5.5 ... 8	
Weight	kg	36	
Ambient temperature	°C	5 ... 40	
Mains power connection 230 V/50 Hz	V/ Hz	207-253 / 50	
Current input at (at 230 V)	A	12	
Mains power connection 230 V/60 Hz	V/ Hz	207-253 / 60	
Current input at (at 230 V)	A	12	
Mains power connection 115 V/60 Hz	V/ Hz	103-127 / 60	
Current input at (at 115 V)	A	14	
Mains power connection 100 V/50-60 Hz	V/ Hz	90-110V/50-60Hz	
Current input (at 100 V)	A	14	

All measurements have been carried out at: rated voltage and frequency
 ambient temperature: 20 °C Technical changes without prior notification reserved.

		F33-EH	F34-EH
Working temperature range	°C	-30 ... 150	-30 ... 150
Temperature stability	°C	±0.03	±0.03
Temperature selection		digital	digital
Temperature indication		LED	LED
Resolution	°C	0.1	0.1
ATC - Absolute Temperature Calibration		1-point	1-point
Temperature control		PID1	PID1
Heater wattage (at 230 V)	kW	2.0	2.0
Heater wattage (at 115 V)	kW	1.0	1.0
Cooling capacity	°C	+20 0 -20	+20 0 -20
Medium ethanol	kW	0.5 0.32 0.12	0.45 0.32 0.14
Refrigerant		R134a	R134a
Circulating pump:			
discharge, max.at 0 bar	l/min	15	15
pressure, max. at 0 l	bar	0.35	0.35
Electrical connections:			
External alarm device	Vdc/mA	24-0 / max. 25	24-0 / max. 25
Overall dimensions (WxDxH)	cm	36x46x69	38x58x62
Bath opening (WxL)	cm	23x14	24x30
Bath depth	cm	20	15
Filling volume from ... to	liters	12 ... 16	14 ... 20
Weight	kg	43	41
Ambient temperature	°C	5 ... 40	5 ... 40
Mains power connection 230 V/50 Hz			
Mains power connection 230 V/50 Hz	V/ Hz	207-253 / 50	207-253 / 50
Current input (at 230 V)	A	12	12
Mains power connection 230 V/60 Hz			
Mains power connection 230 V/60 Hz	V/ Hz	207-253 / 60	207-253 / 60
Current input (at 230 V)	A	12	13
Mains power connection 115 V/60 Hz			
Mains power connection 115 V/60 Hz	V/ Hz	103-127 / 60	103-127 / 60
Current input (at 115 V)	A	15	14
Mains power connection 100 V/50-60 Hz			
Mains power connection 100 V/50-60 Hz	V/ Hz	90-110V/50-60Hz	-----
Current input (at 100 V)	A	15	-----

All measurements have been carried out at: rated voltage and frequency
 ambient temperature: 20 °C Technical changes without prior notification reserved.

Safety installations according to IEC 61010-2-010:

Excess temperature protection	adjustable from 0 °C ... 170 °C
Low liquid level protection	float switch
Classification according to DIN 12876-1	class III
Alarm message	optical + audible (permanent)

Environmental conditions according to IEC 61 010-1:

Use only indoor.

Altitude up to 2000 m - normal zero.

Ambient temperature: +5 ... +40 °C

Air humidity:

Max. rel. humidity 80 % for temperatures up to +31 °C,

linear decrease down to 50 % relative humidity at a temperature of +40 °C

Max. mains fluctuations of ± 10 % are permissible.

Protection class according to IEC 60 529 IP21

The unit corresponds to Class I

Overvoltage category II

Pollution degree 2



Caution:

The unit is not for use in explosive environment.

Standards for interference resistance according to EN 61326-1





This unit is an ISM device classified in Group 1 (using high frequency for internal purposes)

Class A (industrial and commercial range).



Operating instructions

3. Safety notes for the user

3.1. Explanation of safety notes

	<p>In addition to the safety warnings listed, warnings are posted throughout the operating manual. These warnings are designated by an exclamation mark inside an equilateral triangle. “Warning of a dangerous situation (Attention! Please follow the documentation).”</p> <p>The danger is classified using a signal word.</p> <p>Read and follow these important instructions for averting dangers.</p>
	<p>Warning:</p> <p>Describes a possibly highly dangerous situation. If these instructions are not followed, serious injury and danger to life could result.</p>
	<p>Caution:</p> <p>Describes a possibly dangerous situation. If this is not avoided, slight or minor injuries could result. A warning of possible property damage may also be contained in the text.</p>
	<p>Notice:</p> <p>Describes a possibly harmful situation. If this is not avoided, the product or anything in its surroundings can be damaged.</p>

3.2. Explanation of other notes

	<p>Note!</p> <p>Draws attention to something special.</p>
	<p>Important!</p> <p>Indicates usage tips and other useful information.</p>

3.3. Safety recommendations

Follow the safety recommendations to prevent damage to persons or property. Further, the valid safety instructions for working places must be followed.

	<ul style="list-style-type: none"> • Only connect the unit to a power socket with an earthing contact (PE – protective earth)! • The power supply plug serves as a safe disconnecting device from the line and must always be easily accessible. • Place the unit on an even surface on a base made of nonflammable
---	--

material.

- Do not stay in the area below the unit.
- Make sure you read and understand all instructions and safety precautions listed in this manual before installing or operating your unit.
- Never operate the unit without bath fluid in the bath.
- Set the excess temperature safety installation at least 25 °C below the fire point of the bath fluid.
- Do not drain the bath fluid while it is hot!
Check the temperature of the bath fluid prior to draining (e.g., by switching the unit on for a short moment).
- Pay attention to the thermal expansion of bath oil during heating to avoid overflowing of the fluid.
- Prevent water from entering the hot bath oil.
- Use suitable connecting tubing.
- Make sure that the tubing is securely attached.
- Avoid sharp bends in the tubing, and maintain a sufficient distance from surrounding walls.
- Regularly check the tubing for material defects (e.g., for cracks).
- Never operate damaged or leaking units.
- Always turn off the unit and disconnect the mains cable from the power source before performing any service or maintenance procedures, or before moving the unit.
- Always turn off the unit and disconnect the mains cable from the power source before cleaning the unit.
- Always empty the bath before moving the unit.
- Transport the unit with care.
- Sudden jolts or drops may cause damage in the interior of the unit.
- Observe all warning labels.
- Never remove warning labels.
- Never operate units with damaged mains power cables.
- Repairs are to be carried out only by qualified service personnel.



- Some parts of the bath cover and the pump connections may become extremely warm during continuous operation. Therefore, exercise particular caution when touching these parts.



Notice: Check the safety installations at least twice a year!

- Excess temperature protection according to IEC 61010-2-010.
With a screwdriver turn back the adjustable excess temperature protection until the shut-down point (actual temperature).
- Low level protection according to IEC 61010-2-010.
To check the function of the float, it can be manually lowered with a screwdriver for example.



Caution:

The temperature controlling i.e. of fluids in a reactor constitutes normal circulator practice.

We do not know which substances are contained within these vessels.

Many substances are:

- inflammable, easily ignited or explosive
- hazardous to health
- environmentally unsafe

i.e.: **dangerous**

The user alone is responsible for the handling of these substances!

The following questions shall help to recognize possible dangers and to reduce the risks to a minimum.

- Are all tubes and electrical cables connected and installed?
Note:
sharp edges, hot surfaces in operation, moving machine parts, etc.
- Do dangerous steams or gases arise when heating?
Is an exhaust needed when working?
- What to do when a dangerous substance was spilled on or in the unit?
Before starting to work, obtain information concerning the substance and determine the method of decontamination.



WARNING

This product contains chemicals known to the state of California to cause cancer, birth defects or other reproductive harm.





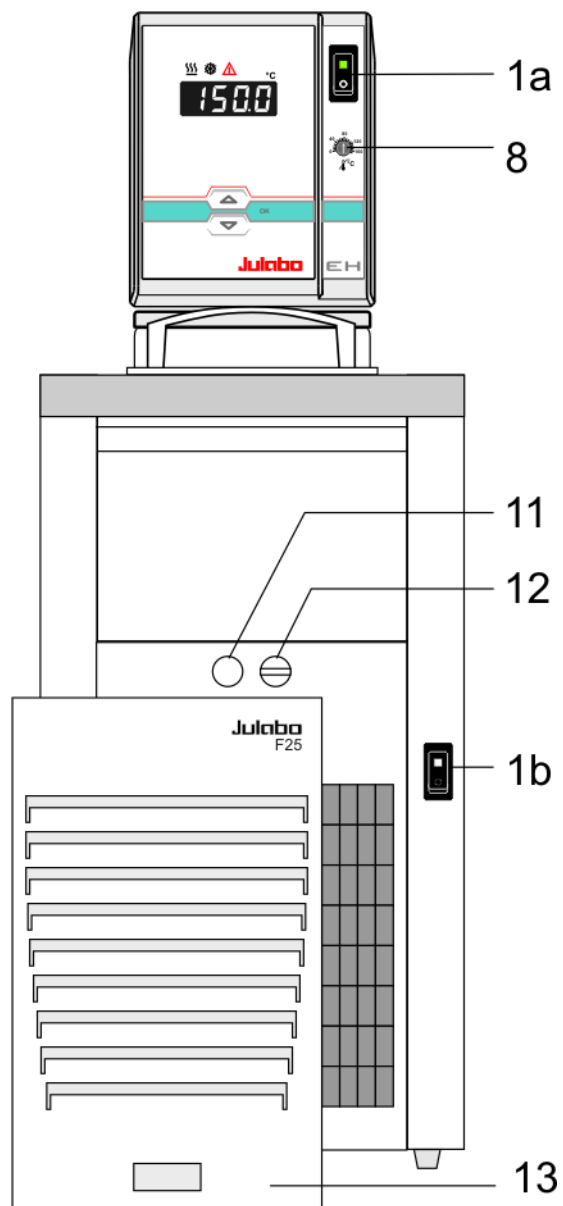



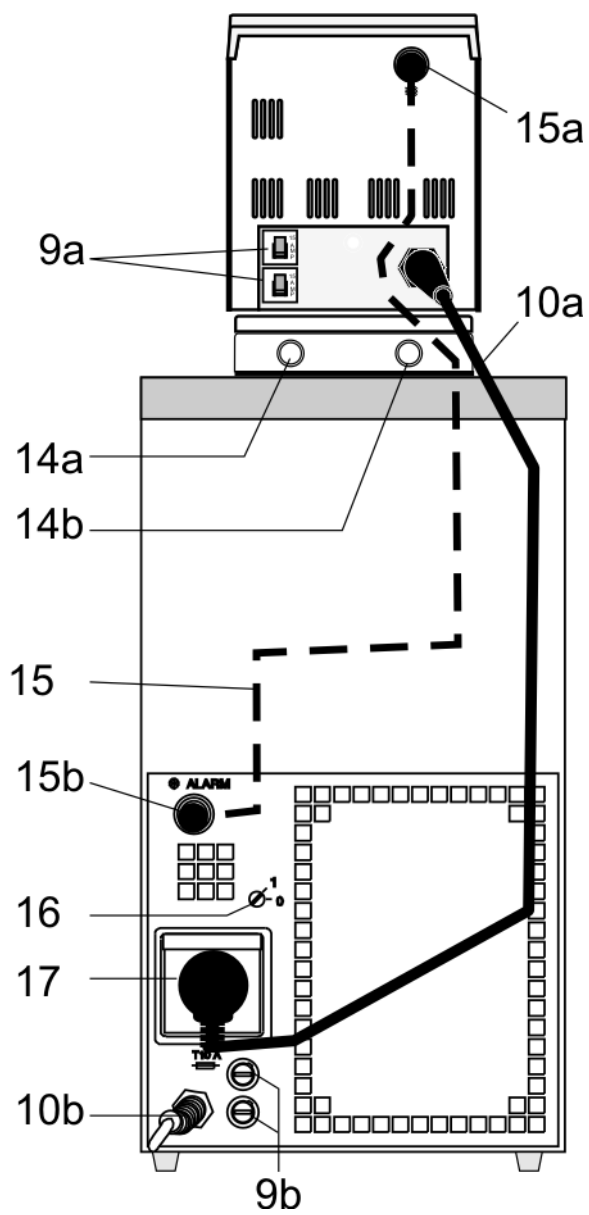



4. Operating controls and functional elements

Front view



Rear view

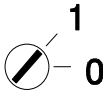

- 1a  Mains power switch, illuminated for circulator
- 1b  Mains power switch, illuminated for cooling machine
- 2  Edit keys
Setpoint increase or decrease
Press keys shortly for step-by-step changes,
Keep the keys pressed for fast change of setpoint
- 3  OK key (store)
- 4  LED temperature display, menu indication
- 5  Control indicator – Heating
- 6  Control indicator – Cooling
- 7  Control indicator – Alarm
- 8  Adjustable excess temperature protection according to IEC 61010-2-010
- 9a  Mains circuit breakers 15 A
- 9b  Mains fuses for cooling machine, T10A
- 10a Mains power cable with plug for circulator
- 10b Mains power cable with plug cooling machine
- 11 Drain port (not on F12)
- 12 Drain tap
- 13 Venting grid, removable
- 14a Pump connector: feed
- 14b Pump connector: return
- 15 Control cable
- 15a  Socket: output for alarm messages or control cable of JULABO refrigerated circulator (not on F12)
- 15b
- 16  Selector dial for cooling machine (only F25, F34)
Position "1" for operation with EH circulator.
- 17 Built-in mains outlet for connection of circulator

5. Preparations

5.1. Installation



- Place the unit on an even surface on a pad made of **non-flammable** material.
F34-EH: The circulator fitted with a stainless steel bridge is placed on on the back of the bath tank leaving the bath open on the front side.
- The place of installation should be large enough and provide sufficient air ventilation to ensure the room does not warm up excessively because of the heat the instrument radiates to the environment. (Max. permissible ambient temperature: 40 °C). With regard to a disturbance in the cooling loop (leakage), the guideline EN 378 prescribes a certain room space to be available for each kg of refrigerant.
The necessary amount of refrigerant is specified on the type plate.
> For 0.25 kg of refrigerant R134a, a room space of 1 m³ is required.
- Keep at least 20 cm of open space on the front and rear venting grids.
- Set selector dial for cooling machine (16) in position "1" for operation with EH circulator.  (only F25, F34)
- Do not set up the unit in the immediate vicinity of heat sources and do not expose to sun light
- Before operating the unit after transport, wait about one hour after setting it up. This will allow any oil that has accumulated laterally during transport to flow back down thus ensuring maximum cooling performance of the compressor.

5.2. Bath fluids



Caution:

Carefully read the safety data sheet of the bath fluid used, particularly with regard to the fire point!

If a bath fluid with a fire point of ≤ 65 °C is used, only supervised operation is possible.

Water:

The quality of water depends on local conditions.

- Due to the high concentration of lime, hard water is not suitable for temperature control because it leads to calcification in the bath.
- Ferrous water can cause corrosion - even on stainless steel.
- Chloric water can cause pitting corrosion.
- Distilled and deionized water is unsuitable. Their special properties cause corrosion in the bath, even in stainless steel.

Recommended bath fluids:

Bath fluid	Temperature range
soft/decalcified water	5 °C to 80 °C
mixture water/glycol, mixture 1:1	-20°C to 50°C



See website for list of recommended bath fluids.

ATTENTION: The maximum permissible viscosity is 30 mm² /s



Caution:

Fire or other dangers when using bath fluids that are not recommended:

Please contact JULABO before using other than recommended bath fluids. Use only nonacidic and noncorrosive bath fluids.

JULABO assumes no liability for damage caused by the selection of an unsuitable bath liquid.

Unsuitable bath fluids are fluids which, e.g.,

- are highly viscous
(much higher than recommended at the respective working temperature)
- have a low viscosity and have creep characteristics
- have corrosive characteristics or
- tend to crack.
- **No liability for use of other bath fluids!**

5.3. Filling / Draining



Notice:

- Pay attention to the thermal expansion of bath oil during heating to avoid overflowing of the liquid.
- Do not drain the bath fluid while it is hot!
Check the temperature of the bath fluid prior to draining (by switching the unit on for a short moment, for example).
- Store and dispose the used bath fluid according to the laws for environmental protection.

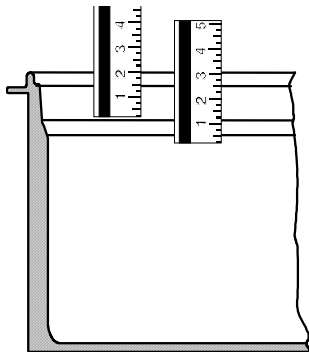

Filling

Take care that no liquid enters the interior of the circulator.

- ① Recommended maximum filling level with water as bath fluid:
20 mm below the tank rim
- ① Recommended maximum filling level with bath oils:
30 mm below the tank rim

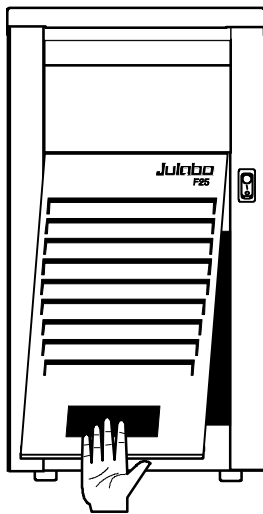

- ① After filling, immerse the samples in the bath or place the lid on the bath, in case the opening is not to be used.

Draining

- Turn off the circulator and cooling machine.
- Hold the venting grid, pull out and remove.
- Slide a short piece of tube onto the drain port (11) and hold it into a pail.
- Unscrew the drain tap (12) and empty the unit completely.
- **Tighten the drain tap.**

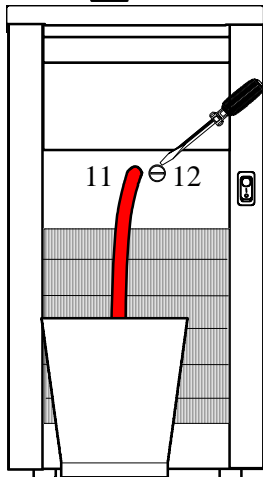

5.4. Temperature application to external systems



Caution: Securely attach all tubing to prevent slipping.

If the circulator is operated without external system, close the pump connector (14a) with the cap nut.

The circulator is used for temperature application to external, closed systems (loop circuit).

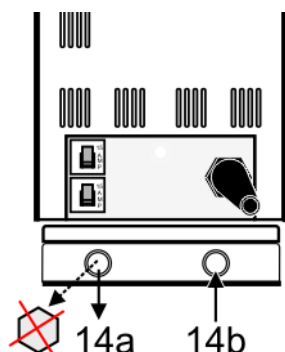

The circulator is used for temperature application to external, closed systems (loop circuit) with simultaneous temperature application in the circulator bath.

Connecting the external system

- Unscrew the collar nuts from the pump connector (14a).
- Slide the tubing onto the pump connectors for feed and return flow (14a, 14b). Secure the tubing with tubing clamps

5.4.1. Tubing

Recommended tubing:

Order No.	Length		Temperature range
8 930 008	1 m	CR [®] tubing 8 mm inner dia.	-20 °C to 120 °C
8 930 010	1 m	CR [®] tubing 10 mm inner dia.	-20 °C to 120 °C
8 930 108	1 m	Viton tubing 8 mm inner dia.	-50 °C to 200 °C
8 930 110	1 m	Viton tubing 10 mm inner dia.	-50 °C to 200 °C
8 930 410	1 m	Insulation for tubing 8 mm or 10 mm inner dia.	-50 °C to 100 °C
8970480		2 Tubing clamps, size 1 for tubing 8 mm ID	
8970481		2 Tubing clamps, size 2 for tubing 10 or 12 mm ID	



*) Adapter for metal tubing M10x1 on M16x1 Order No. 8 970 444



Warning: Tubing:

At high working temperatures the tubing used for temperature application and cooling water supply represents a danger source.

A damaged tubing line may cause hot bath fluid to be pumped out within a short time.

This may result in:

- Burning of skin
- Difficulties in breathing due to hot atmosphere

Safety recommendations

- Employ suitable connecting tubing.
- Make sure that the tubing is securely attached.
- Avoid sharp bends in the tubing, and maintain a sufficient distance from surrounding walls.
- Regularly check the tubing for material defects (e.g. for cracks).
- Preventive maintenance: Replace the tubing from time to time.

5.5. Adjusting the pump flow

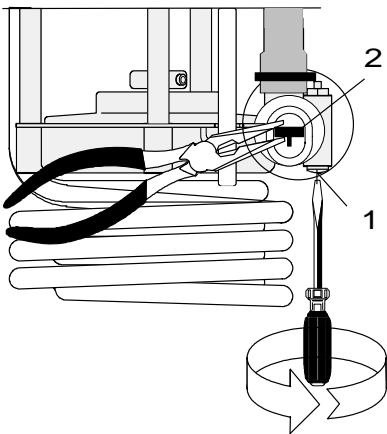

The pump flow is pre-adjusted in the factory and can be modified to suit user requirements.

- Using a screwdriver turn the screw (1) anti-clockwise by 360°.
- Using flat pliers turn the marking of the slide (2) to the desired position.
- Tighten the screw.

Examples:

Internal applications in the bath

- A 100 % internal bath circulation (for large bath tanks)
- B Reduced internal bath circulation (for smooth surface of bath fluid)

External/internal applications

- C 40 % external discharge, 60 % internal circulation (for large bath tanks)
- D 80 % external discharge, 20 % internal circulation (for small bath tanks)

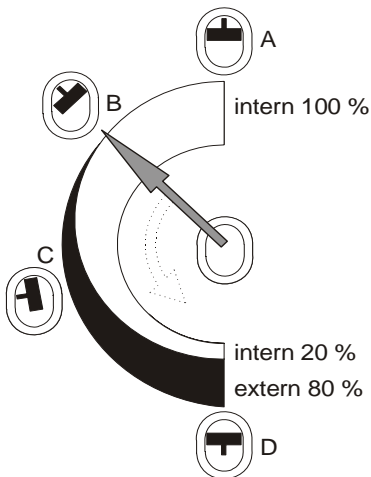

6. Operating procedures

6.1. Power connection



Caution:

- Only connect the unit to a power socket with earthing contact (PE – protective earth)!
- The power supply plug serves as safe disconnecting device from the line and must be always easily accessible.
- Never operate equipment with damaged mains power cables.
- Regularly check the mains power cables for material defects (e.g. for cracks).
- We disclaim all liability for damage caused by incorrect line voltages!

Check to make sure that the line voltage matches the supply voltage specified on the identification plate.

- Connect the circulator with mains power cable (10a) to the mains outlet (17).
- Connect the control cable (15) between the connectors * (15a, 15b).
- Connect the refrigerated circulator with mains power cable (10b) to the mains socket.

6.2. Switching on / Start - Stop



- Switching on:
Turn the unit on with the mains power switch. (1).

- ① The unit performs a self-test. All segments of the 4-digit LED temperature DISPLAY and all indicator lights will illuminate (as illustrated on the left).
The display "OFF" indicates the unit is ready to operate (standby mode).

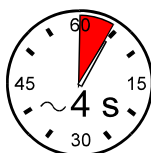

Start:

- Press the **OK** key for about 4 seconds.
The LED temperature DISPLAY indicates the actual bath temperature.



Stop:

- Press the **OK** key for about 4 seconds.
- Turn the unit off with the mains power switch.



Caution: F12

If the circulator is turned off with the mains switch (1a), the refrigerating unit is not switched off simultaneously.
Turn off the refrigerating unit with the mains switch (1b) as well.
Danger of freezing when water is used as bath fluid!



Note: Shorten heat-up time

Whenever cooling is not required because the actual working temperature value is increased by >30 °C for example, turn off the refrigeration unit with the mains switch (1b).

In such case, model combinations connected with the control cable (15) intermittently indicate the message E 21. As soon as the desired bath temperature is reached, turn on the refrigeration unit with the mains switch (1b) again and the message E 21 disappears.

6.3. Automatic / non-automatic start mode

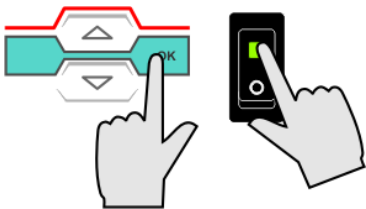

- 1 Keep depressed the **OK** key and
- 2 turn on the circulator with the mains power switch.

For a short while the LED temperature DISPLAY indicates the effective start mode:



⇒ AUTOSTART on.



⇒ AUTOSTART off.

NOTE:

The circulator has been configured and supplied by JULABO according to N.A.M.U.R. recommendations. This means for the start mode, that the unit must enter a safe operating state after a power failure (non-automatic start mode). This safe operating state is indicated by „OFF“ on the LED temperature display. A complete shutdown of the main functional elements such as heater and circulating pump is effected simultaneously.

Should such a safety standard not be required, the AUTOSTART function (automatic start mode) may be activated, thus allowing the start of the circulator directly by pressing the mains power switch or using a timer.



Warning:





For supervised or unsupervised operation with the AUTOSTART function, avoid any hazardous situation to persons or property.

The circulator does no longer conform to N.A.M.U.R. recommendations.

Please make sure that all safety devices of the unit have been set properly.

6.4. Setting the temperatures

Factory setting: 25°C ⓘ Setting can be carried out in the start/stop condition.



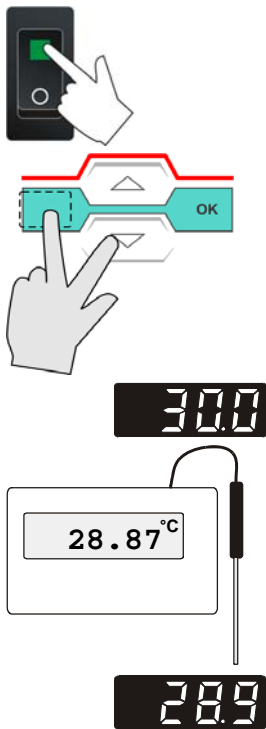
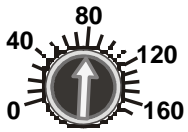

1. Press one of the keys   for a short moment. The setpoint value instead of the actual value is indicated on the display for about 8 seconds. The value can now be changed.
2. Change value:
Press  to set a higher value.
Press  to set a lower value.
Keep the keys depressed for the value to change fast.
3. Press the  key to store the value.

6.5. ATC - Absolute Temperature Calibration



- 1-point calibration:
Calibration of the working sensor is performed at a temperature of 30 °C.
- Place the circulator for example on a 5 litres stainless steel bath and fill the bath with water.
- Set the safety temperature to approx. 80 °C.
- Place a **calibrated** thermometer (resolution: 0.01 °C) in the middle of the bath to measure the actual bath temperature.

1. Turn on the circulator with the mains switch.
2. Start the unit
Press the **OK** key **for about 4 seconds**.
3. Start the calibration:
Press the hidden key and the  key at the same time. The controller attempts to heat up to the working temperature (30 °C). The LED temperature DISPLAY indicates the actual bath temperature.
4. When the working temperature is reached, wait until the circulator maintains a constant bath temperature (after about 3 minutes).
5. Read the bath temperature from the **calibrated** thermometer and set the rounded value on the circulator. (example: 28.87 °C rounded to 28.9 °C).

- Setting the temperature
Press one of the keys   for a short moment. The setpoint value instead of the actual value is indicated on the display. The value can now be changed.
- Change value:
Press  to set a higher value.
Press  to set a lower value.
Keep the keys depressed for the value to change fast.
- Press the **OK** key to store the value.



- For a short while the LED temperature DISPLAY indicates the message „**CAL**“.
- ① Notice:
If the determined value is bigger than the tolerance limit of ± 5 °C, the value is ignored for the input!

6.6. Timer function

With the timer function the operating time can be limited to an allowed time.

6.6.1. Setting the time



Factory setting:



Max. time:



33 h 19 min.



① The setting can only be made in the Stop status.

1. Calling the timer function:

Hold the **OK** key pressed and activate the edit key  shortly. The time which was set last, is shown.

2. Setting the time:

Activate key  to set a higher value .

Activate key  to set a lower value .

Activate the key shortly for single step, hold the key pressed for quick enumeration.

3. Store the set value with the **OK** key .

Example: 120 minutes

① This time remains stored until something is changed.

6.6.2. Timer operation



Timer operation

• Starting the timer:

Hold the **OK** key pressed and activate the edit key  shortly.

① The bath temperature is shown. In case of timer operation the comma in the display is blinking. The set time is counted up to zero. When the time has elapsed, the circulator stops.

• Interrupting the timer / Failure of power supply voltage:

If there is a power failure, or if the unit is switched off at the mains switch, the circulator memorizes the position of the timer. When the power supply is switched on again, the circulator only works off the remaining time.

• Canceling the timer operation:

Press the **OK** key for approx. **4 seconds**.

The timer can be restarted.

6.7. Safety installations according to IEC 61010-2-010

Check the safety installations at least twice a year! See page 13.

6.7.1. Excess temperature protection



Warning:

The excess temperature protection should be set at least 25 °C below the fire point of the bath fluid used.
In the event of wrong setting there is a fire hazard!
We disclaim all liability for damage caused by wrong settings!

This safety installation is independent of the control circuit. When the temperature of the bath fluid has reached the safety temperature, a complete shutdown of the heater and pump is effected.
The alarm is indicated by optical and audible signals (continuous tone) and on the LED-DISPLAY appears the error message "Error 14".

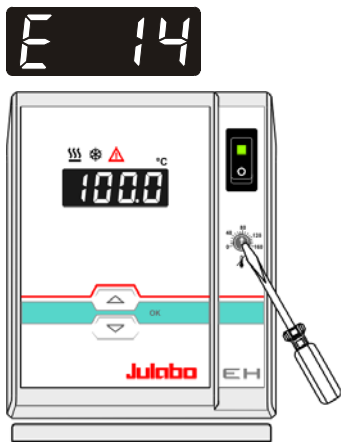

Setting range: 0 °C to 170 °C

- Using a screwdriver turn the setting screw to the desired value.

Recommendation:

Set the excess temperature protector at 5 to 10 °C above the working temperature setpoint.

6.7.2. Low liquid level protection



This safety installation is independent of the control circuit.
If the low liquid level protection device is triggered, a complete shutdown of the heater and circulating pump is effected.
The alarm is indicated by optical and audible signals (continuous tone) and on the LED-DISPLAY appears the error message "Error 01".

- ① Turn off the unit with the mains switch, refill bath fluid and turn the unit on again!



Warning:

For refill always use the same bath fluid type that is already in the bath.
Bath oils must not contain any water contaminants! Explosion hazard at higher temperatures!

Recommendation:

Refill bath oils only at a bath temperature below 70 °C!

7. Troubleshooting guide / Error messages

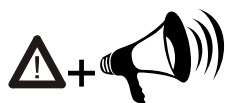

Whenever the microprocessor electronics registers a failure, a complete shutdown of the heater and circulating pump is performed. The alarm light "⚠" illuminates and a continuous signal tone sounds. The LED temperature display indicates the cause for the alarm in form of a code.



Press the **OK** key to quit the audible signal.

E 01

- The circulator is operated without bath fluid, or the liquid level is insufficient.
Replenish the bath tank with the bath fluid.
- Tube breakage has occurred (insufficient filling level due to excessive bath fluid pumped out). Replace the tubing and replenish the bath tank with the bath fluid.

E 02

- During the self-test after switch-on a short-circuit is registered between pin 2 and pin 4 of the control cable or the control cable is interrupted during operation.
Reconnect the cable or eliminate the short-circuit.

E 05

- Cable of the working temperature sensor interrupted or short-circuited.

E 06

- Defect of the working or excess temperature sensor.
Working temperature and excess temperature sensors report a temperature difference of more than 25 °C.

E 12

- Error in A/D converter

E 14

- The excess temperature value lies below the working temperature setpoint.
Set the excess temperature to a higher value.

E 33

- Cable of the excess temperature sensor interrupted or short-circuited.



After eliminating the malfunction, press the mains power switch off and on again to cancel the alarm state.

If the unit cannot be returned to operation, contact an authorized JULABO service station.



Warning without a complete shutdown of the unit:

- Compressor stage 1 does not work.
The motor of the cooling compressor is equipped with an overload protector, which will be activated by excessive temperature in the capsule or by excessive current consumption. Poor air circulation (distance to walls, dirt accumulated on condenser) may cause the motor to be disconnected.
After a short cooling interval, the compressor motor will be automatically reconnected and the message "E 21" no longer appears.
- ① The LED temperature display indicates the cause for the warning in form of a code and an acoustic signal sounds in regular intervals. These messages appear every 4 seconds.

Disturbances that are not indicated.

The electronic pump motor is overload-protected by an electronic current limiter. If viscosity of the bath fluid is or becomes too high, the motor stops running.

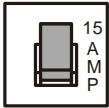

Circulator: Mains circuit breakers (resettable) 15 A

Cooling machine: Fuse T 10.0 A, dia.5 x 20 mm

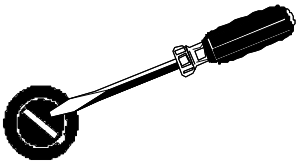

The mains fuses (8b) on the rear of the unit may easily be exchanged as shown on the left.



Warning:

Before exchanging the fuses, turn off the mains power switch and disconnect the power plug from the mains socket!
Only use fine fuses with a nominal value as specified.

Example:

Manufacturer	Supplier	Type	Order No.
Wickmann	Wickmann	G- fuse insert T10,0A 5x20 mm	No. 19195

8. Electrical connections



Notice:

Use shielded cables only.
The shield of the connecting cable is electrically connected to the plug housing.



❄ / Control output

The ❄ connector may be used for control of JULABO refrigerated circulators or as output for alarm messages.

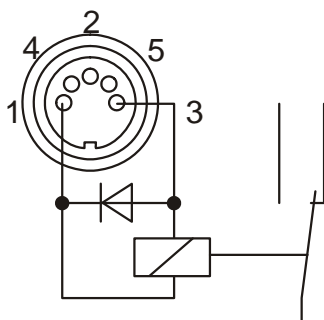

Circuit: Operation = relay powered
 Alarm = relay not powered

Pin assignment:

Pin	Signal
1	+24 V (I max. current 25 mA)
2	0 V
3	Alarm relay
4	Reserved - do not use!
5	Reserved - do not use!

9. Cleaning / repairing the unit



Caution:

- Always turn off the unit and disconnect the mains cable from the power source before cleaning the unit.
Prevent humidity from entering into the circulator.
- Electrical connections and any other work must be performed by qualified personnel only.

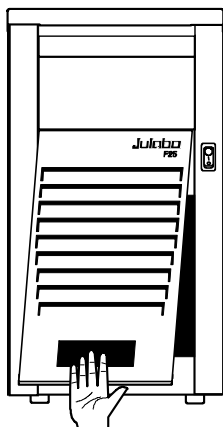

To maintain the full cooling performance, clean the condenser from time to time.

- Switch off the unit, disconnect mains power cable.
- Hold the venting grid, pull out and remove.
- Clean the ribbed condenser with a vacuum cleaner.
- Replace the venting grid.
- Switch on the unit.

Cleaning

For cleaning the bath tank and the immersed parts of the circulator, use low surface tension water (e.g., soap suds).

Clean the outside of the unit using a wet cloth and low surface tension water.

The circulator is designed for continuous operation under normal conditions. Periodic maintenance is not required.

The tank should be filled only with a bath fluid recommended by JULABO. To avoid contamination, it is essential to change the bath fluid from time to time.

Repairs

Before asking for a service technician or returning a JULABO instrument for repair, please contact an authorized JULABO service station.

When returning the unit:

- Clean the unit in order to avoid any harm to the service personnel.
- Attach a short fault description.
- When returning a unit, take care of careful and adequate packing.
- JULABO is not responsible for damages that might occur from insufficient packing.



JULABO reserves the right to carry out technical modifications with repairs for providing improved performance of a unit.

10. WARRANTY PROVISIONS

The following Warranty Provisions shall apply to products sold in North America by Julabo ("Seller") to the entity shown as buyer ("Buyer") on Seller's invoice.

1. **Initial Warranty.** Upon Seller's receipt of payment in full for the products and subject to Buyer's compliance with the terms of sale and any other agreement with Seller relating to the products, Seller warrants to the Buyer that the products manufactured by the Seller are free from defects in material and workmanship for a period not to exceed two (2) years or ten thousand (10,000) hours of operation, whichever comes first, from the date the product is shipped by Seller to Buyer (the "Initial Warranty").

2. **EXCLUSION OF ALL OTHER EXPRESS WARRANTIES; EXCLUSION OF ALL IMPLIED WARRANTIES.** OTHER THAN THE INITIAL WARRANTY, NO OTHER EXPRESS WARRANTIES ARE MADE. ALL IMPLIED WARRANTIES OF EVERY TYPE AND KIND, INCLUDING BUT NOT LIMITED TO ANY IMPLIED WARRANTY OF MERCHANTABILITY OR FITNESS FOR A PARTICULAR PURPOSE OR USE, ARE EXCLUDED IN ALL RESPECTS AND FOR ALL PURPOSES. SELLER DISCLAIMS AND MAKES NO IMPLIED WARRANTIES WHATSOEVER.

3. **Exclusions.** The Initial Warranty does not include damage to the product resulting from accident, misuse, improper installation or operation, unauthorized or improper repair, replacement or alteration (including but not limited to repairs, replacements, or alterations made or performed by persons other than Seller's employees or authorized representatives), failure to provide or use of improper maintenance, unreasonable use or abuse of the product, or failure to follow written installation or operating instructions. Buyer must return the product's record of purchase to the Seller or one of Seller's authorized representatives within thirty (30) days of the date the product is shipped by Seller to Buyer in order to make a claim under the Initial Warranty. Notwithstanding anything contained herein to the contrary, all glassware, including but not limited to reference thermometers, are expressly excluded from the Initial Warranty.

4. **Buyer's sole remedies; Limitations on Seller's Liability.** Buyer's sole and exclusive remedy under the Initial Warranty is strictly limited, in Seller's sole discretion, to either: (i) repairing defective parts; or (ii) replacing defective parts. In either case, the warranty period for the product receiving a repaired or replaced part pursuant to the terms of the Initial Warranty shall not be extended. All repairs or replacements performed by Seller pursuant to these Warranty Provisions shall be performed at Seller's facility in Allentown, Pennsylvania, U.S.A. or Vista, California, U.S.A or at the facility of an authorized representative of Seller, which location shall be determined by Seller in its sole discretion; provided, however, that Seller may, in its sole discretion perform such repairs or replacements at Buyer's facility in which case Buyer shall pay Seller's travel, living and related expenses incurred by Seller in performing the repairs or replacements at Buyer's facility. As a condition precedent to Seller's obligation to repair or replace a product part under the Initial Warranty, Buyer shall (i) promptly notify Seller in writing of any such defect; (ii) shall have returned the product's record of purchase to Seller or to one of Seller's authorized representatives within thirty (30) days of the date the product is delivered to Buyer; and (iii) assist Seller in all respects in its attempts to determine the legitimacy and basis of any claims made by or on behalf of Buyer including but not limited to providing Seller with access to the product to check operating conditions. If Buyer does not provide such written notice to Seller within the Initial Warranty period or fails to return the product's record of purchase as set forth above, Seller shall have no further liability or obligation to Buyer therefore. In no event shall Seller's liability under the Initial Warranty exceed the original purchase price of the product which is the subject of the alleged defect.

5. **THE REMEDIES PROVIDED IN THE INITIAL WARRANTY ARE THE SOLE AND EXCLUSIVE REMEDIES AVAILABLE TO THE BUYER. NOTWITHSTANDING ANYTHING TO THE CONTRARY CONTAINED HEREIN, AND EVEN IF THE SOLE AND EXCLUSIVE REMEDIES FAIL OF THEIR ESSENTIAL PURPOSE FOR ANY REASON WHATSOEVER, IN NO EVENT SHALL SELLER BE LIABLE FOR BUYER'S MANUFACTURING COSTS, LOST PROFITS, GOODWILL, OR ANY OTHER SPECIAL, INDIRECT, PUNITIVE, INCIDENTAL OR**

WARRANTY PROVISIONS

CONSEQUENTIAL DAMAGES TO BUYER OR ANY THIRD PARTY AND ALL SUCH DAMAGES ARE HEREBY DISCLAIMED.

6. **Assignment**. Buyer shall not assign any of its rights or obligations hereunder without the prior written approval of Seller; provided, however, that if Buyer is a distributor of Seller, the rights and obligations of Buyer under these Warranty Provisions shall inure to the benefit of and be binding upon Buyer's customers who provide the product's proof of purchase to Seller pursuant to the terms set forth herein. Seller may assign any or all of its rights or obligations hereunder without Buyer's prior consent.

7. **Governing Law**. The Warranty Provisions and all questions relating to their validity, interpretation, performance, and enforcement shall be construed in accordance with, and shall be governed by, the substantive laws of the Commonwealth of Pennsylvania without regard to its principles of conflicts of law.

8. **Waiver**. Any failure of the part of Seller to insist on strict compliance with the Warranty Provisions shall no way constitute a waiver of such right. No claim or rights arising out of a breach of the Warranty Provisions by Buyer may be discharged in whole or in part by a waiver of the claim or right, unless the waiver is in writing signed by an authorized representative of Seller. Seller's waiver or acceptance of any breach by Buyer of any provisions of the Warranty Provisions shall not constitute a waiver of or an excuse for nonperformance as to any other provision of the Warranty Provisions nor as to any prior or subsequent breach of the same provision.

9. **Freight**. Buyer will arrange and pay for shipping and handling charges for the unit to be returned to the Seller. Seller will arrange and pay for shipping and handling for the return of the unit to the Buyer.