

Operating manual

Recirculating Coolers

FL300

FL601



*English*

**Julabo**  
Innovative Temperature Technology

19534818\_a.doc

04.08.10

# Congratulations!

You have made an excellent choice.

JULABO thanks you for the trust you have placed in us.

This operating manual has been designed to help you gain an understanding of the principles of operating and possibilities of our circulators. For optimum utilization of all functions, we recommend that you thoroughly study this manual prior to beginning operation.

## **Quality Management System**



### The JULABO Quality Management System:

Development, production and distribution of temperature application instruments for research and industries conform to the requirements according to DIN EN ISO 9001:2000. Certificate Registration No. 01 100044846

## **Unpacking and inspecting**

Unpack the recirculating cooler and accessories and check for damages incurred during transit. These should be reported to the responsible carrier, railway, or postal authority, and a request for a damage report should be made. These instructions must be followed fully for us to guarantee our full support of your claim for protecting against loss from concealed damage. The form required for filing such a claim will be provided by the carrier.



## TABLE OF CONTENTS

1. Intended use .....	6
1.1. Description .....	6
2. Operator responsibility – Safety instructions .....	6
2.1. Disposal.....	9
3. Technical specifications .....	10
4. Safety notes for the user.....	16
4.1. Explanation of safety notes .....	16
4.2. Explanation of other notes.....	16
4.3. Safety instructions .....	17
5. Installation.....	19
5.1. Tubing .....	22
6. Operating controls and functional elements.....	23
7. Operating procedures .....	25
7.1. Bath fluids.....	25
7.2. Power connection .....	26
7.3. Filling.....	27
7.4. Switching on / Start - Stop .....	28
7.5. Setting the temperatures .....	29
7.6. AUTOSTART ON / OFF .....	30
7.7. Remote control: activate – deactivate .....	31

8. Safety installations.....	32
8.1. Excess temperature protection.....	32
8.2. Low level protection .....	32
9. Troubleshooting guide / Error messages.....	33
10. Electrical connections.....	35
11. Remote control.....	36
11.1. Setup for remote control.....	36
11.2. Communication with a PC or a superordinated data system.....	37
11.3. List of commands .....	39
11.4. Status messages.....	40
11.5. Error messages.....	40
12. Cleaning / repairing the unit .....	41
13. Adequate storing of operating manual .....	43
14. Draining.....	44
15. WARRANTY PROVISIONS .....	45

## 1. Intended use

JULABO recirculating coolers have been designed for temperature application to specific fluids. The pump connections can be used for cooling applications in an external circuit at a constant temperature.



JULABO water baths are not suitable for direct temperature control of foods, semi-luxury foods and tobacco, or pharmaceutical and medical products. Direct temperature control means unprotected contact of the object with the bath medium (bath fluid).

### 1.1. Description

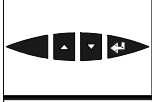

- The recirculating coolers are operated via the splash-proof keypad. The implemented microprocessor technology allows to set and to store the setpoint that can be indicated on the LED temperature display.
- The PID temperature regulation is used to withdraw heat from the bath fluid by means of the cooling machine and to automatically regulate the required need.
- Electrical connections:
  1. The serial interface RS232 allows modern process technology without additional interface.
  2. Alarm output for external alarm message.









## 2. Operator responsibility – Safety instructions

The products of JULABO ensure safe operation when installed, operated, and maintained according to common safety regulations. This section explains the potential dangers that may arise when operating the circulator and also specifies the most important safety precautions to preclude these dangers as far as possible.

The operator is responsible for the qualification of the personnel operating the units.

- The personnel operating the units should be regularly instructed about the dangers involved with their job activities as well as measures to avert these dangers.
- Make sure all persons tasked with operating, installing, and maintaining the unit have read and understand the safety information and operating instructions.
- When using hazardous materials or materials that could become hazardous, the unit may be operated only by persons who are absolutely familiar with these materials and the unit. These persons must be fully aware of possible risks.

If you have any questions concerning the operation of your unit or the information in this manual, please contact us!

Contact	JULABO WEST	JULABO EAST
	2575 Pioneer Avenue, Suite 102 Vista, CA 92081	754 Roble Road, Suite 180 Allentown, PA 18109
	 (760) 842-8010	 (610) 231-0250
	 (760) 842-8015	 (610) 231-0260
	 info @ julabo.com	 info @ julabo.com
	 www.julabo.com	 www.julabo.com

### Safety recommendations for the operator

- You received a product conceived for industrial use. Nevertheless, avoid strikes to the housing, vibrations, damages to the keypad foil (keys, display) or contamination.
- Make sure the product is regularly checked for proper condition. Regularly check (at least every 2 years) the proper condition of the mandatory, warning, prohibition and safety labels.
- Take care that the mains supply features a low impedance to avoid any negative affects on the instrument being operated in the same mains.

- This unit is designed for operation in a controlled electromagnetic environment. This means that transmitting devices (e.g. cellular phones) should not be used in the immediate vicinity. Magnetic radiation may influence other units with components susceptible to magnetic fields (e.g. a monitor). We recommend to keep a minimum distance of 1 m.
- Permissible ambient temperature: max. 40 °C, min. 5 °C.
- Permissible relative air humidity: 50 % (40 °C).
- Do not store in an aggressive atmosphere. Protect from contaminations.
- Do not expose to sunlight.

### **Appropriate Operation**

Only qualified personnel is authorized to perform configuration, installation, maintenance and repairs of the water bath.

Routine operation can also be carried out by untrained personnel who should however be instructed by trained personnel.

### **Use**

For the use according to the intended purpose, special material requirements have to be respected (bath fluids). Only use non-acid and non corroding materials.

Observe all warnings for the used materials (bath fluids) and the respective instructions (safety data sheets). Only use the unit in well ventilated areas. (see page 19).



The recirculating coolers are not for use in explosive atmosphere

When using hazardous materials or materials that could become hazardous, **the operator must** affix the enclosed safety labels to the front of the unit so they are highly visible:

If this unit is intended for use within the United States of America, all 3 warning labels **must** be affixed to the housing of the unit prior to use. Directions for the positioning of the individual warning



labels are enclosed with the warning labels included in the delivery. Warning labels must be easily visible to users.

1		<p>Warning label W00: Colors: yellow, black            Danger area. Attention! Observe instructions.            (operating manual, safety data sheet)</p>
2		<p>Mandatory label M018: Colors: blue, white            Carefully read the user information prior to beginning operation.  <b>Scope: EU</b></p>
or		
2		<p>Semi S1-0701 Table A1-2 #9            Carefully read the user information prior to beginning operation.  <b>Scope: USA, NAFTA</b></p>
3	<p><b>WARNING:</b> This product contains chemicals known to the state of California to cause cancer, birth defects or other reproductive harm.</p>	<p>Warning label Proposition 65</p>

Observe the instructions in the manuals for instruments of a different make that you connect to the circulator, particularly the corresponding safety instructions. Also observe the pin assignment of plugs and technical specifications of the products.

### 2.1. Disposal

This unit contains the refrigerants R134a or R404A, which at this time are not considered harmful to the ozone layer. However, over the long operating period of the unit, disposal rules may change. Therefore, only qualified personnel should handle the disposal.

### 3. Technical specifications

<b>Recirculating Cooler</b>		<b>FL300</b>
Working temperature range	°C	-20 ... +40
Temperature stability	°C	±0.5
Temperature selection: via key pad remote control via personal computer		digital indication on LED-DISPLAY indication on monitor
Temperature indication: Resolution	°C	LED-DISPLAY 0.1
Temperature control		PID 1
Temperature sensor		Pt 100
Excess temperature protection		85 °C - fixed value
Low liquid level protection		float switch
Electrical connections: Computer interface Alarm output		RS232 for external alarm signal
Circulating pump: discharge, max.at 0 bar pressure, max. at 0 Liters	l/min bar	15 0,35

Filling level indicator		sight glass
Filling volume	from ... to	Liters 3 ... 4.5
Dimensions (WxLxH)		cm 25x50x60
Weight		kg 39
Ambient temperature range		°C 5 ... 40
Return flow temperature		°C 80 max.
IP class according to IEC 60 529		IP 21
Cooling compressor		1- stage / air cooled
Refrigerant		R134a

Cooling capacity (at <b>A, B, C</b> )	°C	+20	+10	0	-10	-20
Medium: Mixture water-glycol	kW	0.3	0.25	0.2	0.15	0.1
<b>A</b> Mains power connection 230 V/50 Hz	V/ Hz	207-253 / 50				
Current input at 230 V	A	3.0				
<b>B</b> Mains power connection 208 - 220 V/60 Hz	V/ Hz	197 - 242 / 60				
Current input at 208V / 220 V	A	3.0 / 3.0				
<b>C</b> Mains power connection 115 V/60 Hz	V/ Hz	103-127 / 60				
Current input at 115 V	A	6.0				

Cooling capacity ( <b>D</b> at 200 V/50 Hz)	°C	<u>+20</u>	<u>+10</u>	<u>0</u>	<u>-10</u>	<u>-20</u>
Medium: Mixture water-glycol	kW	0.3	0.25	0.2	0.15	0.06
Cooling capacity ( <b>D</b> at 200 V/60 Hz)	°C	<u>+20</u>	<u>+10</u>	<u>0</u>	<u>-10</u>	<u>-20</u>
Medium: Mixture water-glycol	kW	0.3	0.25	0.2	0.15	0.09
<b>D</b> Mains power connection 200 V/50-60 Hz	V/ Hz	190-254 / 50 190-244 / 60				
Current input at 200 V	A	3.0				

All measurements have been carried out at: rated voltage and frequency,  
ambient temperature: 20 °C

**Recirculating Cooler****FL601**

---

Working temperature range	°C	-20 ... +40
Temperature stability	°C	±0.5
Temperature selection: via key pad		digital indication on LED-DISPLAY
remote control via personal computer		indication on monitor
Temperature indication:		LED-DISPLAY
Resolution	°C	0.1
Temperature control		PID 1
Temperature sensor		Pt 100
Excess temperature protection		85 °C - fixed value
Low liquid level protection		float switch
Cooling capacity	°C	<u>+20</u> <u>+10</u> <u>0</u> <u>-5</u> <u>-20</u>
Medium: Mixture water-glycol	kW	0.6 0.5 0.4 0.33 0.2
Cooling compressor		1- stage / air cooled
Refrigerant		R404A
Electrical connections:		
Computer interface		RS232
Alarm output		for external alarm signal

**Recirculating Cooler****FL601**

Circulating pump:

discharge, max. at 0 bar	l/min	23
pressure, max. at 0 Liters	bar	1.0

-----

Filling level indicator sight glass

Filling volume from ... to Liters 5.5 ... 8

Dimensions (WxLxH) cm 32x50x60

Weight kg 48

Ambient temperature range °C 5 ... 40

Return flow temperature °C 80 max.

IP class according to IEC 60 529 IP 21

Mains power connection 230 V/50 Hz V/ Hz 207-253 / 50

Current input at 230 V A 4.6

Mains power connection 208 - 220 V/60 Hz V/ Hz 197 - 242 / 60

Current input at 208V / 220 V A 5.0

Mains power connection 115 V/60 Hz V/ Hz 103-127 / 60

Current input at 115 V A 9.1

---

All measurements have been carried out at: rated voltage and frequency,  
ambient temperature: 20 °C

### Warning functions and safety installations

Excess temperature protection	85 °C - fixed value
Low liquid level protection	float switch
Alarm message	optical + audible (permanent)
Excess temperature - Warning function	75 °C
Overload protection	for compressor and pump motor
Classification according to DIN 12876-1	class I

### Environmental conditions according to IEC 61 010-1:

Use only indoor.

Altitude up to 2000 m - normal zero.

Ambient temperature: +5 ... +40 °C

Air humidity:

Max. rel. humidity 80 % for temperatures up to +31 °C,

linear decrease down to 50 % relative humidity at a temperature of +40 °C

Max. mains fluctuations of  $\pm 10$  % are permissible.

The unit corresponds to Class I

Overvoltage category II

Pollution degree 2



#### **Caution:**

The unit is not for use in explosive atmosphere

Standards for interference resistance according to EN 61326-1

This unit is an ISM device classified in Group 1 (using high frequency for internal purposes) Class A (industrial and commercial range).

## 4. Safety notes for the user

### 4.1. Explanation of safety notes



In addition to the safety warnings listed above, warnings are posted throughout the manual. These warnings are designated by an exclamation mark inside an equilateral triangle. "Warning of a dangerous situation (Attention! Please follow the documentation)."

The danger is classified using a signal word.

Read and follow these important instructions.



**Warning:**

Describes a possibly highly dangerous situation. If these instructions are not followed, serious injury and danger to life could result.



**Caution:**

Describes a possibly dangerous situation. If this is not avoided, slight or minor injuries could result. A warning of possible property damage may also be contained in the text.



**Notice:**

Describes a possibly harmful situation. If this is not avoided, the product or anything in its surroundings can be damaged.

### 4.2. Explanation of other notes



**Note!**

Draws attention to something special.



**Important!**

Indicates usage tips and other useful information.



### 4.3. Safety instructions

Follow the safety recommendations to prevent damage to persons or property. Further, the valid safety instructions for working places must be followed.



- Only connect the unit to a power socket with earthing contact (PE – protective earth)!
- The power supply plug serves as a safe disconnecting device from the line and must always be easily accessible.
- Place the instrument on an even surface on a pad made of non-inflammable material.
- Do not stay in the area below the unit.
- Make sure you read and understand all instructions and safety precautions listed in this manual before installing or operating your unit.
- Never operate the unit without bath fluid in the bath.
- Do not drain the bath fluid while it is hot or cold!  
Check the temperature of the bath fluid prior to draining (by switching the unit on for a short moment for example).
- Use suitable connecting tubing.
- Make sure that the tubing is securely attached.
- Avoid sharp bends in the tubing, and maintain a sufficient distance from surrounding walls.
- Regularly check the tubing for material defects (e.g., for cracks).
- Never operate damaged or leaking equipment.
- Always turn off the unit and disconnect the mains cable from the power source

before performing any service or maintenance procedures, or before moving the unit.

- Always turn off the unit and disconnect the mains cable from the power source before cleaning the unit.
- Always empty the bath before moving the unit.
- Transport the unit with care.
- Sudden jolts or drops may cause damage in the interior of the unit.
- Observe all warning labels.
- Never remove warning labels.
- Never operate equipment with damaged mains power cables.
- Repairs are to be carried out only by qualified service personnel.



- Risk of injury for hands. Close cover carefully.



- Some parts of the bath tank and the pump connections may become extremely cold during continuous operation. Therefore, exercise particular caution when touching these parts.



**WARNING**

This product contains chemicals known to the state of California to cause cancer, birth defects or other reproductive harm.

## 5. Installation

- Place the unit on an even surface on a base made of **nonflammable** material.
- Cooling machine, pump motor and electronics produce intrinsic heat that is dissipated via the venting openings.! Never cover these openings!
- Keep at least 20 cm of open space on the front and rear venting grids.
- The place of installation should be large enough and provide sufficient air ventilation to ensure the room does not warm up excessively because of the heat the instrument rejects to the environment. (Max. permissible ambient temperature: 35 °C). For a fault (leakage) in the refrigeration system, the standard EN 378 prescribes a certain room space to be available for each kg of refrigerant.

The necessary amount of refrigerant is specified on the type plate.

> For 0.25 kg of refrigerant R134a, 1 m<sup>3</sup> of space is required.

> For 0.48 kg of refrigerant R404A, 1 m<sup>3</sup> of space is required.

Example: model FL601 with 0.5 kg filling quantity of refrigerant R404A = 1.04 m<sup>3</sup> volume

Example: FL300 ↓

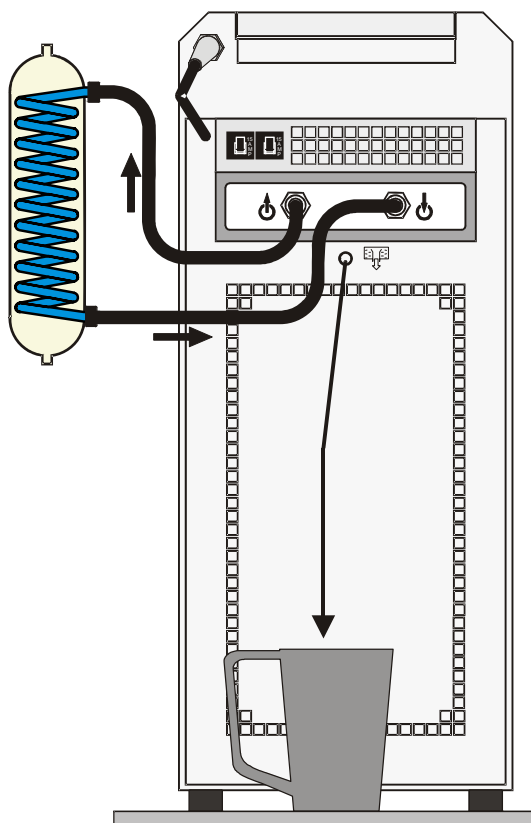

- Connect the tubings for cooling the external system to the pump connectors M16x1 for feed and return (12) on the rear of the recirculating cooler.

↑ - Feed    ↓ - Return

- Connect a piece of tubing to the overflow connector (13) and drain into a suitable vessel, which always has to be placed lower than the exit „Overflow“.
- Do not set up the unit in the immediate vicinity of heat sources and do not expose to sun light.
- Before operating the unit after transport, wait about one hour after setting it up. This will allow any oil that has accumulated laterally during transport to flow back down thus ensuring maximum cooling performance of the compressor.



**Caution:**

Securely attach all tubing to prevent slipping.



**Notice: Flood hazard!**

In case the system to be cooled is located at a higher level than the recirculating cooler, take note of bath liquid flowing back when the unit is switched off.

**Return flow safety device**

Should the filling volume of the bath tank not be sufficient, prevent the liquid from flowing back by using shut-off valves..

Order No.	Description	Suitable for
8 970 456	Shut-off valve for loop circuit, M16x1	FL300/FL601

The following questions shall help to recognize possible dangers and to reduce the risks to a minimum.

- Are all tubes and electrical cables connected and installed?  
Note:  
sharp edges, hot surfaces in operation, moving machine parts, etc.
- What to do when a dangerous substance was spilled on or in the unit?  
Before starting to work, obtain information concerning the substance and determine the method of decontamination.

## 5.1. Tubing



### Caution:

- Employ suitable connecting tubing.
- Make sure that the tubing is securely attached.
- Avoid sharp bends in the tubing, and maintain a sufficient distance from surrounding walls.
- Regularly check the tubing for material defects (e.g. for cracks).
- Preventive maintenance: Replace the tubing from time to time.

### Recommended tubing:

Order No.		Suitable for
8930008	1 m CR <sup>®</sup> -tubing 8 mm inner dia. (-20 ... +120°C)	FL300
8930308	1 m Reinforced tubing 8 mm inner dia. (-40 ... +120°C)	FL601
8930312	1 m Reinforced tubing 12 mm inner dia. (-40 ... +120°C)	FL601

### Tubing insulation

8930410	1 m Insulation, 14 mm inner dia..	CR <sup>®</sup> -tubing 8 mm inner dia
8930412	1 m Insulation, 18 mm inner dia.	Reinforced tubing 8 mm inner dia.
8930413	1 m Insulation, 23 mm inner dia.	Reinforced tubing 12 mm inner dia.

### Tube clamps

8970480	2 Tube clamps, size 1	CR <sup>®</sup> -tubing 8 mm inner dia
8970481	2 Tube clamps, size 2	Reinforced tubing 8 mm inner dia.
8970482	2 Tube clamps, size 3	Reinforced tubing 12 mm inner dia.

## 6. Operating controls and functional elements

Example: FL300 Front view

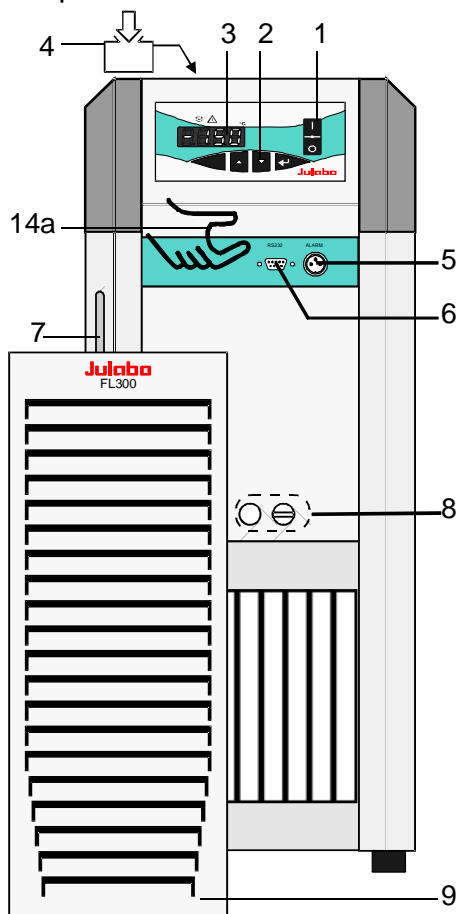

Top view

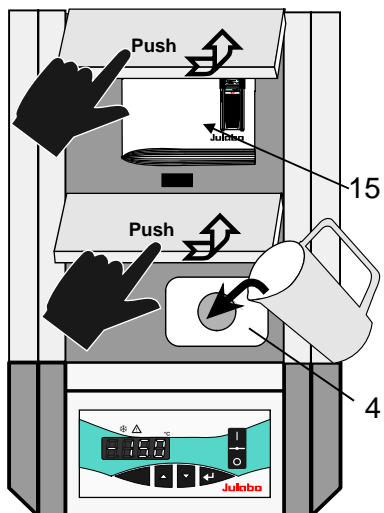







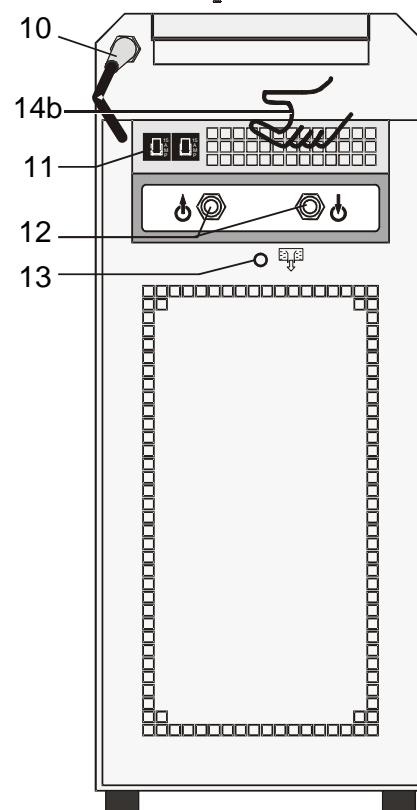







4 Protection lid for fill in opening

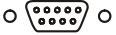

15 Protection lid for storing place of operating manual

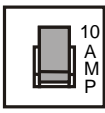
Rear view



- 1  Mains power switch, splash-water protected  
  - | on
  - off
- 2.0  **Keypad**, splash-water protected
- 2.1  Edit keys (set point increase or decrease)
- 2.2  Enter key Store set point value / parameter
- 3.0 **Indication**
- 3.1  LED temperature display
- 3.2  Control indicator – Cooling
- 3.3  Control indicator – Alarm
- 4.0  Filling opening
- 5  Alarm output (for external alarm signal)
- 6  Interface RS232: remote control via personal computer  
RS232
- 7  Filling level indication
- 8  Drain port
- 9  Venting grid, removable
- 10  Mains power cable with plug
- 11  Mains circuit breakers (resettable)  
10  
A  
M  
P
- 12  Pump connector M16x1: ↑ - Feed  
Pump connector M16x1: ↓ - Return
- 24



13		Overflow connector
14a		Handle: front
14b		Handle: rear
15		Protection lid for storing place of operating manual

## 7. Operating procedures

### 7.1. Bath fluids



#### **Caution:**

No liability for use of other bath liquids!

Please contact JULABO before using other than recommended bath fluids. JULABO takes no responsibility for damages caused by the selection of an unsuitable bath fluid

**Do not use alcohols.**

#### **Water:**

The quality of water depends on local conditions.

- Due to the high concentration of lime, hard water is not suitable for temperature control because it leads to calcification in the bath.
- Ferrous water can cause corrosion - even on stainless steel.
- Chloric water can cause pitting corrosion.
- Distilled and deionized water is unsuitable. Their special properties cause corrosion in the bath, even in stainless steel.

**Water:** - No liability for use with water.

Danger of freezing at working temperatures  $<5\text{ }^{\circ}\text{C}$ .

## Recommended bath fluids:

Bath fluids	Temperature range
soft/decalcified water	5 °C to 80 °C



See website for list of recommended bath fluids.

**Contact:** see page 7

## 7.2. Power connection



### **Caution:**

- Only connect the unit to a power socket with earthing contact (PE – protective earth)!  
We disclaim all liability for damage caused by incorrect line voltages!
- The power supply plug serves as safe disconnecting device from the line and must be always easily accessible.
- Never operate equipment with damaged mains power cables.
- Regularly check the mains power cables for material defects (e.g. for cracks).

Make sure that the line voltage and frequency match the supply voltage specified on the type plate.

### 7.3. Filling

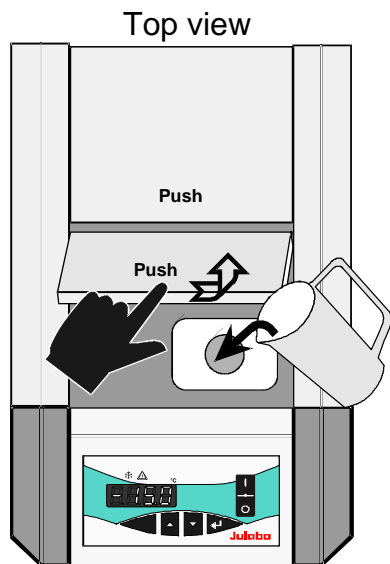

Filling level indicator (13)

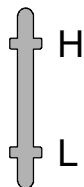

Take care that no liquid enters the interior of the circulating cooler.

- ① Connect the tubing from the external system to the pump connectors and check for leaks



Respect instructions from page 19 to page 22!

- ① Check to make sure that the drain tap (8) is closed.

- Unlock and open lid of fill in opening (4) by slightly pushing.
- Fill in tempering fluid up to marking „H“ of the filling level indicator.
- Turn the mains switch (1) on (Switching on - see page 28).
- Switch on unit. To do so press button  for approx. 4 seconds.
- Tempering fluid is pumped into the externally connected system.  
Refill fluid up to marking „H“.
- The recirculating cooler is ready for operation.

## 7.4. Switching on / Start - Stop

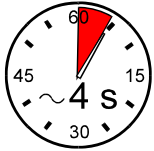
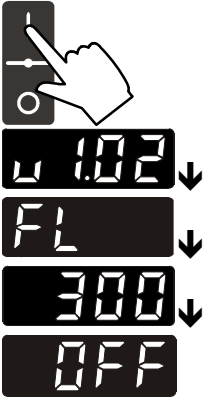

### Switching on:

The recirculating cooler is turned on and off with the mains switch.

The unit performs a self-test. All segments of the 4-digit LED temperature DISPLAY and all indicator lights will illuminate (as illustrated on the left).

Then the software version and the type of unit is indicated.

Examples: (v 1.02) (FL300)

The display "OFF" indicates the unit is ready to operate (standby mode).

**Start:** Press enter  for about 4 seconds.

The LED temperature DISPLAY indicates the actual bath temperature.

**Stop:** Press enter  for about 4 seconds.

Turn the unit off with the mains power switch.

## 7.5. Setting the temperatures

Factory setting:  
25 °C

ⓘ Setting can be carried out in the start/stop condition.

1. Press one of the keys ▼ ▲ for a short moment.  
The setpoint value instead of the actual value is indicated on the display for about 8 seconds.  
The value can now be changed.
2. Change value:  
Press ▲ to set a higher value.  
Press ▼ to set a lower value.  
Keep the keys depressed for the value to change fast.
3. Press enter ↵ to store the value.

## 7.6. AUTOSTART ON / OFF

The recirculating cooler has been configured and supplied by JULABO according to N.A.M.U.R. recommendations. This means for the start mode, that the unit must enter a safe operating state after a power failure (non-automatic start mode). This safe operating state is indicated by „OFF“ on the LED temperature display. A complete shutdown of the main functional elements such as compressor and circulating pump is effected simultaneously.

Should such a safety standard not be required, the AUTOSTART function (automatic start mode) may be activated, thus allowing the start of the circulator directly by pressing the mains power switch or using a timer.



Keep depressed enter  and turn on the unit with the mains power switch.

For a short while the LED DISPLAY indicates the effective start mode:

 ⇒ AUTOSTART on.       ⇒ AUTOSTART off.



### **Warning:**

For supervised or unsupervised operation with the AUTOSTART function, avoid any hazardous situation to persons or property.

The circulator does no longer conform to N.A.M.U.R. recommendations.

## 7.7. Remote control: activate – deactivate

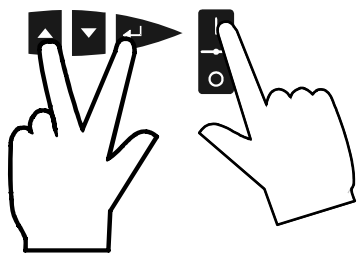

(Interface OFF)

10FF

(Interface On)

10n ↓

u 102 ↓

FL ↓

300 ↓

rOFF

The recirculating cooler is to be prepared for remote control by a personal computer via the serial interface RS232.  
Set the interface item from >IOFF< to >ION<.

### Remote control: activate – deactivate:

- Switch off recirculating cooler by pressing the mains switch and wait approx. 5 seconds.
- Keep depressed the keys ▲ and enter ↵ simultaneously and turn on the unit with the mains power switch.

>I OFF< No remote control via RS232 (Factory setting)

>I On< Remote control via RS232

- ① The software version and the type of unit is indicated (see example on the left).

The display "rOFF" indicates the unit is ready to be operated via remote control.

## 8. Safety installations

### 8.1. Excess temperature protection



This safety installation is independent of the control circuit.

When the temperature of the bath fluid has reached the safety temperature (85 °C), a complete shutdown of the compressor and pump is effected.

The alarm is indicated by optical and audible signals (continuous tone) and on the LED-DISPLAY appears the error message "Error 14".

### 8.2. Low level protection



This safety installation is independent of the control circuit.

If the low liquid level protection device is triggered, a complete shutdown of the compressor and circulating pump is effected.

The alarm is indicated by optical and audible signals (continuous tone) and on the LED-DISPLAY appears the error message "Error 01".

- ⓘ Turn off the unit with the mains switch, refill bath fluid and turn the unit on again!



#### **Caution:**

For refill always use the same bath fluid type that is already in the bath.



**Notice:**

Check the low liquid level protection device at least twice a year!

- To execute a functional test, drain the liquid until the alarm for low liquid level is triggered. Refill liquid afterwards.

## 9. Troubleshooting guide / Error messages

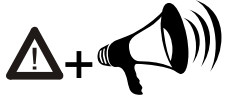

Whenever the microprocessor electronics registers a failure, a complete shutdown of the compressor and circulating pump is performed. The alarm light "⚠" illuminates and a continuous signal tone sounds.

The LED temperature display indicates the cause for the alarm in form of a code.



Press enter  to quit the audible signal.



- The recirculating cooler is operated without bath fluid, or the liquid level is insufficient.  
Replenish the bath tank with the bath fluid.
- Tube breakage has occurred (insufficient filling level due to excessive bath fluid pumped out). Replace the tubing and replenish the bath tank with the bath fluid.



Cable of the working temperature sensor interrupted or short-circuited.



Error in A/D converter



The return temperature is above the switch-off value of the high temperature protection (85°C). Check dimensioning of application.  
Use a stronger recirculating cooler if necessary.

---



After eliminating the malfunction, press the mains power switch off and on again to cancel the alarm state.

If the unit cannot be returned to operation, contact an authorized service station.

---



**Warning without a complete shutdown of the unit**

Excess temperature warning starting at 75 °C

The return temperature soon reaches the switch-off value of the high temperature protection (85 °C).

---

If the unit cannot be returned to operation, contact an authorized JULABO service station.

**Disturbances that are not indicated.**

Overload protection:: a) for cooling machine  
b) for pump motor

After a short cooling interval, the unit will automatically start running.

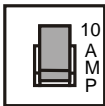

Mains circuit breakers (resettable) –10A.

## 10. Electrical connections



**Notice:** Use shielded cables only.

The shield of the connecting cable is electrically connected to the plug housing.

The unit ensures safe operation if connecting cables with a maximum length of 3 m are used. The use of longer cables does not affect proper performance of the unit, however external interferences may have a negative impact on safe operation.

### RS232 serial interface

This port can be used to connect a computer with an RS232 cable for remote control of the recirculating cooler.

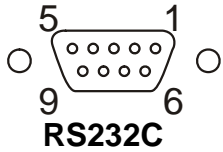

#### Pin assignments:

Pin 2	RxD	Receive Data
Pin 3	TxD	Transmit Data
Pin 5	0 VD	Signal GND
Pin 6	DTR	Data terminal ready
Pin 7	RTS	Request to send
Pin 8	CTS	Clear to send

#### Accessories:

Order No.	Description
8 980 073	RS232 interface cable 9-pol./9-pol. , 2,5 m
8 900 110	USB interface adapter cable

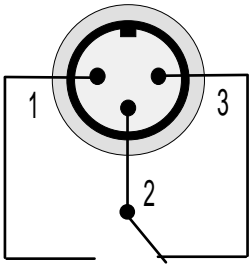

### Alarm output

Potential-free change-over contact for external alarm signal.

Pin 2 and 3 are connected in case of an alarm.

Pin 2 and 1 are connected in "OFF" or "rOFF" condition or mains switch "Off".

Switching capacity max. 30 W / 30 VA

Switching voltage max. 30 V~/–

Switching current max. 1 A

## 11. Remote control

### 11.1. Setup for remote control

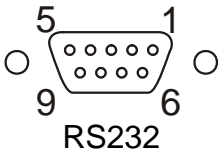

Check the interface parameters for both interfaces (on recirculating cooler and PC) and make sure they match.

**Interface parameters are pre-determined.**

<b>Type</b>	RS232
<b>Baudrate</b>	4800 bauds
<b>Parity</b>	even
<b>Handshake</b>	hardware handshake

## 11.2. Communication with a PC or a superordinated data system

If the recirculating cooler is put into remote control mode the MULTI-DISPLAY (LED) will read „R -OFF-„ = REMOTE STOP. The recirculating cooler is now operated via the computer.

In general, the computer (master) sends commands to the recirculating cooler (slave). The recirculating cooler sends data (including error messages) only when the computer sends a query.



In remote control mode:

After a power interruption the order to start and all values which have to be adjusted must be resent from the personal computer via the interface.

AUTOSTART is not possible.

A transfer sequence consists of:

- command out/in command
- space (↔; Hex: 20) out/in command
- parameter (the character separating decimals in a group is the period) out command
- end of file (↵; Hex: 0D) out/in command
- The response (data string) after an **in** command is always followed by a line feed (LF, Hex: 0A).



### Important times for a command transmission:

To ensure a safe data transfer, the time gap between two commands should be at least 250 ms.

The recirculating cooler automatically responds to an **in** command with a data string followed by a LF (Line Feed). The next command should only be sent after 10 ms.

The commands are divided into **in** or **out** commands.

**in** commands: asking for parameters to be displayed

**out** commands: setting parameters



The **out** commands are valid only in remote control mode.

Examples:

Command to set the working temperature to 15,5 °C:

**out\_sp\_00 ⇔ 15.5↵**

Command to ask for the working temperature

**in\_sp\_00↵**

Response from the recirculating cooler:

**15.5↵ LF**

### 11.3. List of commands

**out commands:** Setting parameters or temperature values.

Command	Parameter	Response of recirculating cooler
out_mode_05	0	Stop the unit = R –OFF-.
out_mode_05	1	Start the unit.
out_sp_00	xxx.xx	Set working temperature

**in commands:** Asking for parameters or temperature values to be displayed.

Command	Parameter	Response of recirculating cooler
version	none	Number of software version (V X.xx)
status	none	Status message, error message (see page 40 )
in_pv_00	none	Actual bath temperature.
in_sp_00	none	Working temperature
in_mode_05	none	Recirculating cooler in Stop/Start condition: 0 = Stop 1 = Start

## 11.4. Status messages

Status messages	Description
00 MANUAL STOP	Recirculating cooler in „OFF“ state.
01 MANUAL START	Recirculating cooler in keypad control mode.
02 REMOTE STOP	Recirculating cooler in „r OFF“ state.
03 REMOTE START	Recirculating cooler in remote control mode.

## 11.5. Error messages

Error messages	Description
-01 LOW LEVEL ALARM	Low liquid level alarm.
-05 WORKING SENSOR ALARM	Working temperature sensor short-circuited or interrupted.
-03 EXCESS TEMPERATURE WARNING	High temperature warning. Starting at 75 °C (no deactivation) The return temperature soon reaches the switch-off value of the high temperature warning function (85 °C)
-07 I <sup>2</sup> C-BUS ERROR	Internal error when reading or writing the I <sup>2</sup> C bus.
-08 INVALID COMMAND	Invalid command.
-09 COMMAND NOT ALLOWED IN CURRENT OPERATING MODE	Invalid command in current operating mode.
-10 VALUE TOO SMALL	Entered value too small.
-11 VALUE TOO LARGE	Entered value too large.



Error messages	Description
-12 TEMPERATURE MEASUREMENT ALARM	Error in A/D converter.
-14 EXCESS TEMPERATURE PROTECTOR ALARM	The return temperature is above the switch-off value of the high temperature warning function of 85 °C. Check dimensioning of application. Use a stronger recirculating cooler if necessary.

## 12. Cleaning / repairing the unit



### **Caution:**

Always turn off the unit and disconnect the mains cable from the power source before cleaning the unit.

Prevent humidity from entering into the circulator.

Electrical connections and any other work must be performed by qualified personnel only.

**Notice:**

Risk of injury for hands when mounting the venting grid.

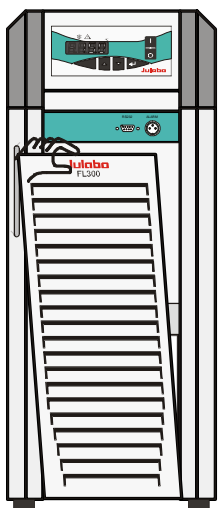

To maintain the full cooling performance, clean the condenser from time to time.

- Switch off the unit, disconnect mains power cable.
- Hold the venting grid, pull out and remove.
- Clean the ribbed condenser with a vacuum cleaner.
- Replace the venting grid.
- Switch on the unit.

**Cleaning:**

Clean the outside of the unit using a wet cloth and low surface tension water. The recirculating cooler is designed for continuous operation under normal conditions. Periodic maintenance is not required.

The tank should be filled only with a bath fluid recommended by JULABO. To avoid contamination, it is essential to change the bath fluid from time to time.

**Repairs:**

Before asking for a service technician or returning a JULABO instrument for repair, please contact an authorized JULABO service station.

When returning the unit:

- Clean the unit in order to avoid any harm to the service personnel
- Attach a short fault description.
- When returning a unit, take care of careful and adequate packing.
- JULABO is not responsible for damages that might occur from insufficient packing.



JULABO reserves the right to carry out technical modifications with repairs for providing improved performance of a unit.

**13. Adequate storing of operating manual**

Store the operating manual at the foreseen place at the unit and lock it by means of the protection lid (15).

## 14. Draining



### Notice:

Store and dispose the used bath fluid according to the laws for environmental protection.



Risk of injury for hands when mounting the venting grid.

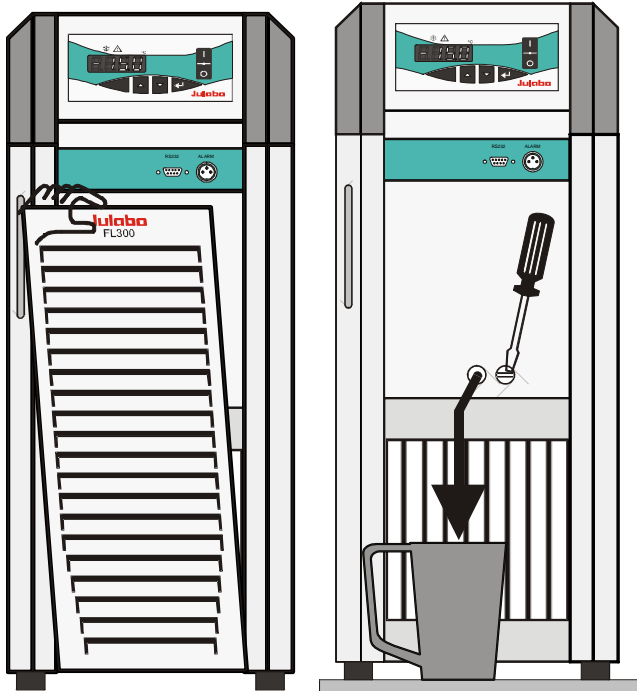

- Turn off the unit and disconnect the mains cable from the power source.
- Hold the venting grid, pull out and remove.
- Slide a short piece of tube onto the drain connection (8) and hold it into a container.
- Loosen the drain screw a few turns and drain the unit completely.
- Close the drain tap and replace the venting grid.

## 15. WARRANTY PROVISIONS

The following Warranty Provisions shall apply to products sold in North America by Julabo (“Seller”) to the entity shown as buyer (“Buyer”) on Seller’s invoice.

1. **Initial Warranty.** Upon Seller’s receipt of payment in full for the products and subject to Buyer’s compliance with the terms of sale and any other agreement with Seller relating to the products, Seller warrants to the Buyer that the products manufactured by the Seller are free from defects in material and workmanship for a period not to exceed two (2) years or ten thousand (10,000) hours of operation, whichever comes first, from the date the product is shipped by Seller to Buyer (the “Initial Warranty”).

2. **EXCLUSION OF ALL OTHER EXPRESS WARRANTIES; EXCLUSION OF ALL IMPLIED WARRANTIES.** OTHER THAN THE INITIAL WARRANTY, NO OTHER EXPRESS WARRANTIES ARE MADE. ALL IMPLIED WARRANTIES OF EVERY TYPE AND KIND, INCLUDING BUT NOT LIMITED TO ANY IMPLIED WARRANTY OF MERCHANTABILITY OR FITNESS FOR A PARTICULAR PURPOSE OR USE, ARE EXCLUDED IN ALL RESPECTS AND FOR ALL PURPOSES. SELLER DISCLAIMS AND MAKES NO IMPLIED WARRANTIES WHATSOEVER.

3. **Exclusions.** The Initial Warranty does not include damage to the product resulting from accident, misuse, improper installation or operation, unauthorized or improper repair, replacement or alteration (including but not limited to repairs, replacements, or alterations made or performed by persons other than Seller’s employees or authorized representatives), failure to provide or use of improper maintenance, unreasonable use or abuse of the product, or failure to follow written installation or operating instructions. Buyer must return the product’s record of purchase to the Seller or one of Seller’s authorized representatives within thirty (30) days of the date the product is shipped by Seller to Buyer in order to make a claim under the Initial Warranty. Notwithstanding anything contained herein to the contrary, all glassware, including but not limited to reference thermometers, are expressly excluded from the Initial Warranty.

4. **Buyer's sole remedies; Limitations on Seller's Liability.** Buyer's sole and exclusive remedy under the Initial Warranty is strictly limited, in Seller's sole discretion, to either: (i) repairing defective parts; or (ii) replacing defective parts. In either case, the warranty period for the product receiving a repaired or replaced part pursuant to the terms of the Initial Warranty shall not be extended. All repairs or replacements performed by Seller pursuant to these Warranty Provisions shall be performed at Seller's facility in Allentown, Pennsylvania, U.S.A. or Vista, California, U.S.A or at the facility of an authorized representative of Seller, which location shall be determined by Seller in its sole discretion; provided, however, that Seller may, in its sole discretion perform such repairs or replacements at Buyer's facility in which case Buyer shall pay Seller's travel, living and related expenses incurred by Seller in performing the repairs or replacements at Buyer's facility. As a condition precedent to Seller's obligation to repair or replace a product part under the Initial Warranty, Buyer shall (i) promptly notify Seller in writing of any such defect; (ii) shall have returned the product's record of purchase to Seller or to one of Seller's authorized representatives within thirty (30) days of the date the product is delivered to Buyer; and (iii) assist Seller in all respects in its attempts to determine the legitimacy and basis of any claims made by or on behalf of Buyer including but not limited to providing Seller with access to the product to check operating conditions. If Buyer does not provide such written notice to Seller within the Initial Warranty period or fails to return the product's record of purchase as set forth above, Seller shall have no further liability or obligation to Buyer therefore. In no event shall Seller's liability under the Initial Warranty exceed the original purchase price of the product which is the subject of the alleged defect.

5. **THE REMEDIES PROVIDED IN THE INITIAL WARRANTY ARE THE SOLE AND EXCLUSIVE REMEDIES AVAILABLE TO THE BUYER. NOTWITHSTANDING ANYTHING TO THE CONTRARY CONTAINED HEREIN, AND EVEN IF THE SOLE AND EXCLUSIVE REMEDIES FAIL OF THEIR ESSENTIAL PURPOSE FOR ANY REASON WHATSOEVER, IN NO EVENT SHALL SELLER BE LIABLE FOR BUYER'S MANUFACTURING COSTS, LOST PROFITS, GOODWILL, OR ANY OTHER SPECIAL, INDIRECT, PUNITIVE, INCIDENTAL OR CONSEQUENTIAL DAMAGES TO BUYER OR ANY THIRD PARTY AND ALL SUCH DAMAGES ARE HEREBY DISCLAIMED.**

6. **Assignment.** Buyer shall not assign any of its rights or obligations hereunder without the prior written approval of Seller; provided, however, that if Buyer is a distributor of Seller, the rights and obligations of Buyer under these Warranty Provisions shall inure to the benefit of and be binding upon Buyer's customers who provide the product's proof of

purchase to Seller pursuant to the terms set forth herein. Seller may assign any or all of its rights or obligations hereunder without Buyer's prior consent.

7. **Governing Law.** The Warranty Provisions and all questions relating to their validity, interpretation, performance, and enforcement shall be construed in accordance with, and shall be governed by, the substantive laws of the Commonwealth of Pennsylvania without regard to its principles of conflicts of law.

8. **Waiver.** Any failure of the part of Seller to insist on strict compliance with the Warranty Provisions shall no way constitute a waiver of such right. No claim or rights arising out of a breach of the Warranty Provisions by Buyer may be discharged in whole or in part by a waiver of the claim or right, unless the waiver is in writing signed by an authorized representative of Seller. Seller's waiver or acceptance of any breach by Buyer of any provisions of the Warranty Provisions shall not constitute a waiver of or an excuse for nonperformance as to any other provision of the Warranty Provisions nor as to any prior or subsequent breach of the same provision.

9. **Freight.** Buyer will arrange and pay for shipping and handling charges for the unit to be returned to the Seller. Seller will arrange and pay for shipping and handling for the return of the unit to the Buyer.

# Julabo

JULABO WEST

2575 Pioneer Avenue, Suite 102

Vista, CA 92081

 (760) 842-8010

 (760) 842-8015

 info @ julabo.com

 [www.julabo.com](http://www.julabo.com)

# Julabo

JULABO EAST

754 Roble Road, Suite 180

Allentown, PA 18109

 (610) 231-0250

 (610) 231-0260

 info @ julabo.com

 [www.julabo.com](http://www.julabo.com)

Changes without prior notification reserved Printed in Germany

1.953.4818 BU6 01/09